

VETEK



Personal Scale VRB-250 and 300

USER MANUAL



Read this manual carefully before using the instrument

INDEX

2.	GENERAL RULES.....	PAGE 2
3.	SAFETY.....	PAGE 3
4.	TECHNICAL SPECIFICATION.....	PAGE 3
5.	INDICATOR.....	PAGE 4
6.	INSTALLATION.....	PAGE 5
7.	INSTRUCTION FOR USE.....	PAGE 5
8.	PRINTER FUNCTIONS.....	PAGE 8
9.	SETTING SETUP.....	PAGE 9
10.	ERROR MESSAGE.....	PAGE 10
11.	MAINTENANCE AND ASSISTANCE.....	PAGE 10
12.	CONFORMITY.....	PAGE 10
13.	IDENTIFICATION LABELS.....	PAGE 11
14.	SCRAPPING AND WASTE DISPOSAL.....	PAGE 11
16.	WARRANTY.....	PAGE 12
16.	ASSEMBLY-USE MECHANICAL TELESCOPIC HEIGHT METER (OPTIONAL).....	PAGE 13
17.	THERMAL PRINTER (OPTIONAL).....	PAGE 15

By choosing the **WUNDER** mod. **RB** or **RB-L** or **RB cable** professional electronic scale, you have purchased a high precision instrument.

Since over 40 years **WUNDER** has placed its experience at the service of health. This instrument is compliant with national standards in hospitals and clinics with medical class I with measurement function and is calibrated in conformity with accuracy class III.

The instrument is characterised by the possibility of fixing the electronic terminal to the weighing platform by means of a column or else installing the terminal autonomously.

The instrument is equipped with a dual LCD electronic terminal with triple reading to simultaneously view Weight, Height, and BMI

2. GENERAL RULES

 **Carefully read this manual before using the instrument as it supplies**

important indications concerning OPERATING SAFETY AND MAINTENANCE.

The descriptions and illustrations supplied in this manual are not binding.

WUNDER reserves the right to modify its products as deemed convenient in order to approve them without being committed to update this publication.

Conventions:

The following symbols have been used in this manual:



0470 MEDICAL CERTIFICATION



METROLOGICAL CERTIFICATION AND APPROVAL FOR MEDICAL USE



ACCURACY CLASS



ASSISTANCE WARRANTY CERTIFICATE



ATTENTION!

PLACED BEFORE DETERMINING PROCEDURES. COMPLIANCE FAILURE CAN DAMAGE THE PRODUCT



WARNING!

PLACED BEFORE DETERMINING PROCEDURES. COMPLIANCE FAILURE CAN HARM THE OPERATOR OR PATIENT OR DAMAGE THE PRODUCT



WASTE DISPOSAL



TYPE B PARTS SUPPLIED



BATTERY POWER



INDICATION OF WEIGHT FUNCTIONALITY

INDICATION OF STABLE WEIGHT



INTERFERENCE COULD OCCUR NEAR THE APPLIANCES



DUAL INSULATION

3. SAFETY

WARNINGS!

Operators must read this manual carefully, comply with the instructions it contains and become familiar with the correct use and maintenance procedures of the instrument.

- Retain this manual for consultation and as a help in staff training

- Do not overload the instrument beyond its maximum capacity
- Do not apply loads abruptly.
- Do not press the keys with sharp or pointed objects
- Do not try to open the instrument.
- Do not remove seals from the instrument.
- Do not short-circuit the battery terminals
- Use only the power supply provided by Wunder. Before using it, make sure that the local mains voltage is compatible with the voltage of the adapter shown on the identification plate
- Regularly check the integrity of the instrument's power cord and make sure it does not come in contact with hot appliances
- Make sure that the power cord does not create obstruction hazards
- Unplug the instrument before cleaning it
- Do not place the instrument in water or other liquids
- Perform maintenance and subsequent metric verifications regularly

4. THECHNICAL SPECIFICATION

Model	RB Basic	RB Medium	RB L RB with cable
Capacity	200kg	300 kg	200kg
Division	50-100g	100 g	50-100g
MDD OIML	Class III		
Unit weight	kg		
Display	LCD 1" con 5 digits attivi		
Function Key	ON / ZERO / OFF, HOLD / BMI, TARA, PRINT		
Power	Rechargeable Batteries Pack- Adapter 12 V - 2 A		
Operation temperature	da 5°C a 35°C		

5. INDICATOR

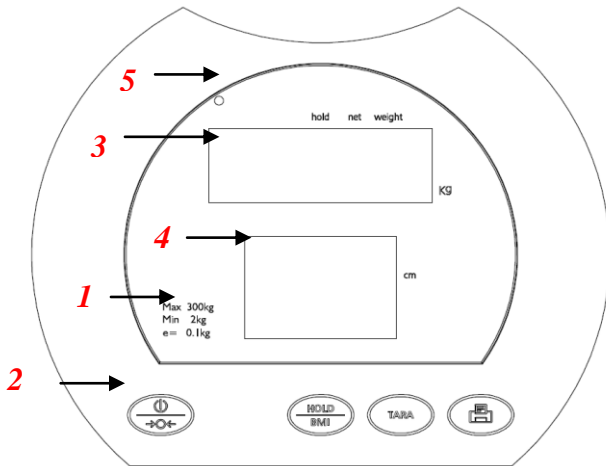

- 1. Weighing capacity and division
- 2. Key function
- 3. Main LCD: Weight
- 4. Second LCD automatically calculates BMI
- 5. Power display

Key functions

Key	Description
	Key ON. To reset the display (OFF) continuous press 3 seconds. Zero the scale ($\pm 2\%$ of full capacity)
	To hold weighing result on the display/ determine stable weighing value. Function BMI
	Tare un-wanted weight
	Print out data.

Function Display Symbols

- Stable symbol: To indicate that the weight is stable.
- Minor weight: Weight under zero.
- Zero symbols: Weight is at zero point.
- Low battery: Battery need to charge or replaced.

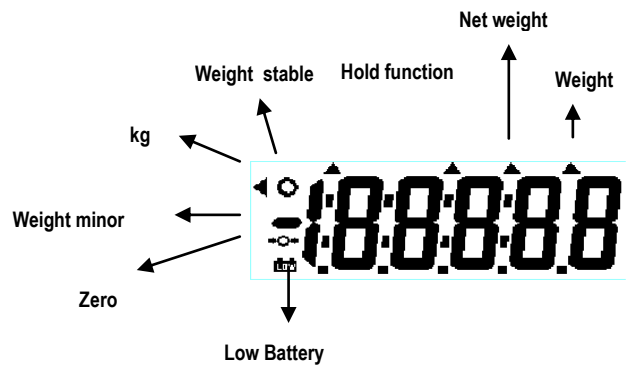

6. INSTALLATION



ONLY FOR COLUMN SCALE

After removing the instruments from the packing check the integrity and right contents

Put the scale far from source from of heat e vibration.

Put the scale on stable surface.

Assembly

Assembling column to the platform

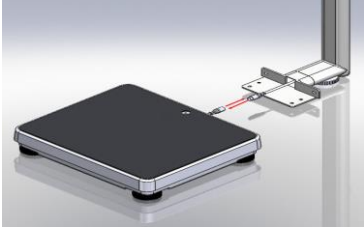
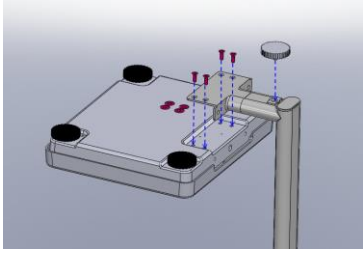

	<ul style="list-style-type: none"> • Connecting wire between column and platform first
	<ul style="list-style-type: none"> • Flip the scale platform on the bench • Fix with 4 screw the column at the platform • Place to the ground the scale and adjust the 5 adjustable feet. • For use connect the external power supply with the electric current

7. ISTRUCTION FOR USE

7.1Time setting

Long press PRINT key for 3 seconds to enter the TIME SETTING mode, beginning with the top row, with the flashing digit. Press PRINT key after successful change to move to next step.

EX: To input Dec 25, 2008, 8:00am.

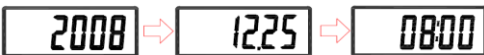
	<p>Enter year: Using TARE keys to decrease the value, press HOLD key to move to next digit. Press PRINT key after successful entry to move to next stage.</p>
	<p>Enter date: Using TARE keys to decrease the value, press HOLD key to move to next digit. Press PRINT key after successful entry to move to next stage.</p>
	<p>Enter time: Using TARE keys to decrease the value, press HOLD key to move to next digit. Press PRINT key after successful setting.</p>
	<p>Display Format YYYY→MM.DD→TT:SS</p>

7.2 Instruction for charging and connecting

If  prompt displays on the LCD, please charge the scale with exclusive adaptor.

Locate adaptor plug on the rear side of indicator.

The battery should be recharged at least every 3 months regardless if it is used or not. After a long period in storage, e.g. over 3 months, the battery should run a full cycle (charge/discharge) to allow it to restore to full capacity.



Ac Jack connector

7.2a Rechargeable Batteries

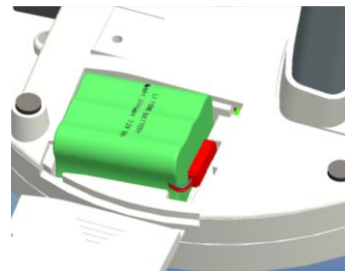
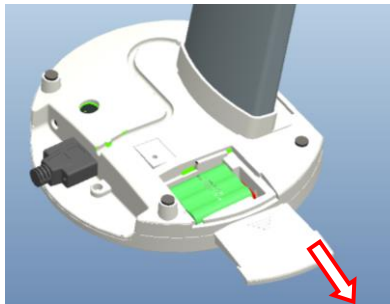

1. Open the battery cover, and take the battery out.
2. Disconnect the rechargeable battery pack then replace it by a new one. Put the battery back then arrange the connector in place well.

7.3 Weighing

Switch on the scale using  key. The diagnostic scale self-check is performed and the software version is displayed.

The „0,00 kg” weight displays on the screen, now the scale is ready for weighing.

Note: If display is not at 0.0kg while switching power on. Kindly press  key to zero the scale which can be used at any time to zero the scale.

7.4 Hold function

The scale is provided with the integrated hold function to determine the average weight. It enables people to be weighed accurately although they are not still on the scale platform.

- Switch 'ON' the scale using [ON/ZERO/OFF] key. The diagnostic self-check will be performed and after that „0.0 kg” will display on the screen with 'stable' and 'zero sign'.
- Move the object/ person on the scale platform.
- Press the [HOLD/BMI] key once. The 'HOLD' will display on the screen with blinking triangle and after few seconds the average of fluctuating weight will display on the screen and will lock on the display.
- To release the locked weight on display simply press the [HOLD/BMI] key again and the display will return to normal mode automatically.
- [HOLD/BMI] key function can be activated before or after putting the weight on the tread platform. But in case of weighing unstable person it is

recommended to press [HOLD/BMI] key after the person moves on the tread platform.

7.5 BMI function

<p>In normal mode, long press [HOLD/BMI] key 3sec to enter into BMI mode.</p> <p>The second display will show last height and the extreme left digit will blink.</p>	
<p>Use [TARE] to decrease value and press HOLD to change to next digit. Press [ON/ZERO/OFF] key to confirm height value.</p>	
<p>When the display shows "Hold", please stand on the scale platform, Proceed to weigh as normal. The instrument will show the weight, height, and BMI value.</p>	
<p>To release the locked weight on display simply press the [HOLD/BMI] key again and the display will return to normal mode automatically.</p>	

7.6 Tare function

Tare allows the user to zero the instrument to cancel the weight of a container/ clothes from the reading of the instrument, thus giving the true weight of the product/ person being tested.

Turn on the scale using  key.

When  displays on the screen and scale beeps twice, Place the object (clothes) need to be tare on the tread platform.

Press  after the weight stabilizes and stable sign appears on the display.

Display will return to 

Place the item/ baby need to be weighed (without removing the tare object). The weighing result is the Net weight of the item / baby.

To delete the saved tare value, remove the tare object from the tray and press  key again.

8. PRINTER FUNCTIONS

Weight can be printed for records using RS232 interface cable. After weighing simply press PRINT key to print out the results

The format presented below is the standard format of results print-out and cannot be changed.

More informations info@wunder.it or service@wunder.it

WUNDER	
Date/Month/Year	hour:minute
Peso/Weight	30.00kg
Altezza/ Height	100.0cm
Indice Massa Corporea BMI(Body Mass Index)	30.0
Sottopeso	
<u>Underweight</u>	<u><18</u>
Normopeso	
<u>Normal weight</u>	<u>18-24.9</u>
Sovrappeso	
<u>Pre-obesity</u>	<u>25-29.9</u>
Obesità calaae I	
<u>Obesity class I</u>	<u>30-34.9</u>
Obesità calaae II	
<u>Obesity class II</u>	<u>35-39.9</u>
Obesità calaae III	
<u>Obesity class III</u>	<u>>40</u>

Set parameters of the scale interface on the connected device. It is not possible to change the scale parameters.

Baud rate: 9600 bps

Parity check: None

Data length: 8 bits

Stop bit: 1 bit

Handshake: RTS/CTS

Data code: ASCII

Serial RS232

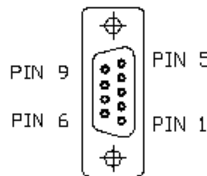

Piedino	Segnale
2	TXD
3	RXD
5	GND

Connector RS232

Connecting with PC

- [Start Hyper Terminal](#)

Start Hyper Terminal program from clicking

Start Menu → Programs → Accessories → Communication → Hyper Terminal.

- [New Connection Description](#)

Give new connection a name then click OK.

- [Select Your COM Port](#)

Click Connect to select your COM port. Usually there's only one option for select. Then click OK.

- Port Settings

Click Bits per second to set up rate at 9600, Data bits at 8, Parity at None, Stop bits at 1 and Flow control at Hardware. Then click OK to complete your setting.

- Output Data

When press the PRINT key to output data from scale to PC or an Optional Printer.

9. SETTING SETUP

Switch ON the scale and long press  key for 3 seconds, first "SETUP" and then "A.OFF" will display successively.

AUTO-OFF TIME SETUP

This enables operator to select the auto turn OFF time of the device.





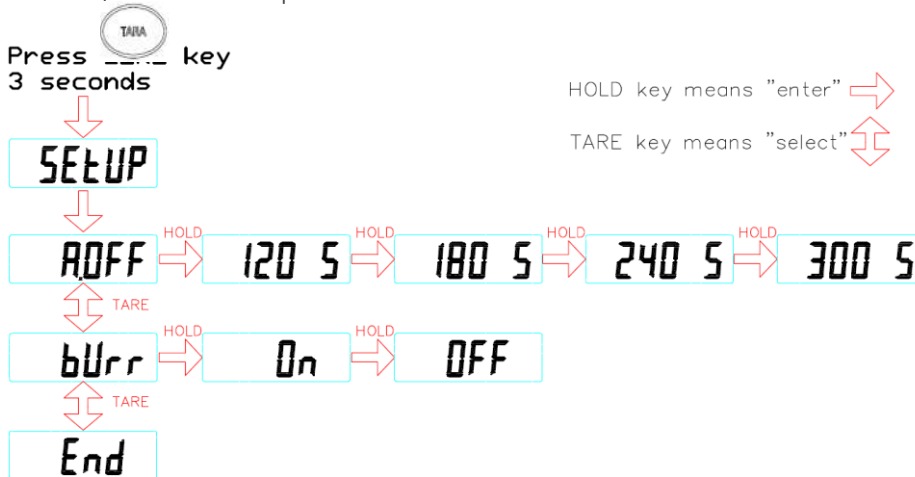

BUZZER ON/OFF SETUP

This enables operator to select beep sound ON/OFF.

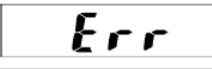

Note: To confirm the settings, please press  when **End** displays on the display.

10.ERROR MESSAGE

ERROR MESSAGE	REASON	ACTION
	Low Battery: This warning shows that the voltage of battery is too low to use	Please replace a new battery or plug the AC adaptor for operation.
	Overload: The total load exceeds the maximum capacity of scale	Please reduce the loading and try again.
	Counting error (too high): Indicates that the signal from the load cell/s is too height	This error is normally caused by a serious fault on the scales such as a faulty load cell or wiring. Please contact the local service representative.
	Counting error (too low): Indicates that the signal from the load cell/s is too low	This error is normally caused by a serious fault on the scales such as a faulty load cell or wiring. Please contact the local service representative.
	Zero count over calibration zero range +10% while power on	Please re-calibrate the instrument.
	Zero count under calibration zero range -10% while power on	Please re-calibrate the instrument.
	EEPROM Error: Indicates that there is a fault with the scales software	This error is normally caused by a serious fault on the scales such as a faulty load cell or wiring. Please contact the local service representative.

11. MAINTENANCE AND ASSISTANCE

For better and longer duration of the product it should receive thorough general cleaning periodically.

The instrument must be cleaned with a soft cloth moistened with water or neutral detergent, without using solvents or abrasive substances. If the instrument remains idle for a long period, remove the batteries from the terminal.

During shipping, make sure not to subject the instrument to blows or excessive mechanical stress.

In case of repairs or assistance, contact your dealer or an authorised service centre contacting service2@wunder.it or sales@wunder.it.

12. CONFORMITY

WUNDER MODEL RB or RB-L or RB CABLE ELECTRONIC SCALE SERIAL N°

We hereby certify that this instrument has been inspected and has successfully passed the functional test.
It complies with the following standards and directives:

EN 45501 / EN60601-1-2 / EN60601-1
93/42/EEC – Medical Devices Directive

13. IDENTIFICATION LABELS

<p>WUNDER SA.BI. srl DK 0199.336</p> <p>M</p> <p>RB (WU 150) Matr. 0021</p> <p>CE 13 0291</p> <p>Max 300 kg e= 100 g T= -300 kg 5°C / 35°C</p>	<p>RB VANO BATTERIE</p> <p>Per la sostituzione della batteria (modello ricaricabile tipo :RETC 7,2 V 2000 mAh vedere il manuale di istruzioni)</p> <p>To replace the battery (rechargeable sealed type :RETC 7,2 V 2000 mAh see the manual)</p>
<p>Temperatura di stoccaggio: 0-60°C</p> <p>Storage Conditions Temperature :0-60°C</p> <p>RB -RB-L stoccaggio</p>	<p>WUNDER Sa.Bi. S.r.L</p> <p>Model : RB (W150)</p> <p>Internally powered equipment with battery or supplied by external model AD-8057 (DK)</p> <p>Internamente alimentata con batteria o da AC/DC alimentatore esterno modello AD-8057 (DK)</p> <p>12V 2A</p> <p>    </p> <p>SER. NR.</p>
<p>CONFORME ALLA DIRETTIVA 93/42 CEE</p> <p>CE 0470</p>	

14. SCRAPPING AND WASTE DISPOSAL

If set aside for a long period, protect those parts which could be damaged due to dust build-up

Scrapping

When you decide to no longer use this item, we recommend making it unusable. We also recommend making those parts which could be sources of danger harmless

Waste disposal  EU 2002/96/EC

This product complies with the EU Directive 2002/96/EC. The symbol of the crossed-out waste bin on the appliance indicates that the product, needing to be treated separately from household waste, at the end of its useful life must be completed in a separate collection facility for electric and electronic appliances or returned to the dealer upon purchase of a new equivalent appliance. The user is responsible for bringing the appliance to an appropriate collection structure at the end of its life. Appropriate separate collection and sending the appliance for recycling, treatment and environmentally compatible waste disposal contributes to avoid possible negative effects on the environment and health and favours the recycling of the materials the product is made of.

For more detailed information regarding available collection systems, contact your local waste disposal service or the shop where the product was purchased.

As consumers, you are obliged by law to return used or dead batteries. You may deposit old batteries at public collection spots in your town or else with any battery dealer who has placed specific collectors for this purpose. Even when scrapping electric and electronic appliances, they must be removed and deposited in specific collectors.

NOTE: The following symbols indicate the presence of harmful substances

Pb Pb = batteries containing Lead

Cd Cd = batteries containing Cadmium

Hg Hg = Batteries containing Mercury

 **ATTENTION!**

Do not throw electric parts and used batteries away with household waste. Dispose of the batteries by means of your closest collection centres.

15. WARRANTY

This certificate must be kept until the warranty has expired.

It must be presented together with the invoice, tax receipt or delivery note providing the name of the dealer and date of purchase whenever a technical intervention is required. Otherwise the user will lose any warranty rights.

The warranty takes effect from the date of purchase and is valid during the entire period foreseen by the current catalogue/pricelist.

By warranty we mean the replacement or repair free of charge of parts making up the appliance which, at the discretion of the manufacturer, are deemed faulty from the origin; Wunder therefore has the faculty of repairing or replacing the item.

The warranty does not cover:

- shipping faults, damage caused by falls, carelessness or tampering
- damage caused by incapability of using the appliance and of its improper use
- damage caused by an insufficient or inadequate electrical system or alterations resulting from environmental, climatic or other types of conditions
- damage due to incorrect installation of the appliance and repairs carried out by unauthorised personnel
- Interventions at home for convenience controls or presumed defects
- Routine maintenance and that which can be considered normal wear from use
- consumables such as: power supplies, batteries, keyboards, plates, wheels, heads, rolls, load cells faulty due to blows or overloads

Service can also be refused when the appliance has been changed or transformed in any way.

In case of interventions at one's home, the customer must pay the fixed fee; if however the appliance is repaired at an authorised Wunder Service Centre, expenses and relative travel risk are borne by the user.

Wunder will not be held liable for damage of any nature caused directly or indirectly to persons, animals or objects resulting from failure to comply with all the instructions indicated in this manual or anyway resulting from improper use.

The Court of Bergamo has jurisdiction in case of any dispute











16. ASSEMBLY-USE MECHANICAL TELESCOPIC HEIGHT METER (OPTIONAL)



ATTENTION!

ONLY FOR COLUMN SCALE

HEIGHT ROD KIT

1.Metal support for telescopic height meter			 side view metal support		
2. Black abs support height meter					
3.Screws	 A)	 B)	 C)	 D)	 E)
	N°02 screws T.E. (M5x16)	N°02 slotted screws (M5x25)	N°01 Allen Screws (M6x12)	N°02 nuets ø 5	N° 02 washers ø 5
4.Tools	 Tools		 Allen tools		

Picture 1: Assemble white metal support with abs black part white the screws (B+E). Lock all with the screws (D)

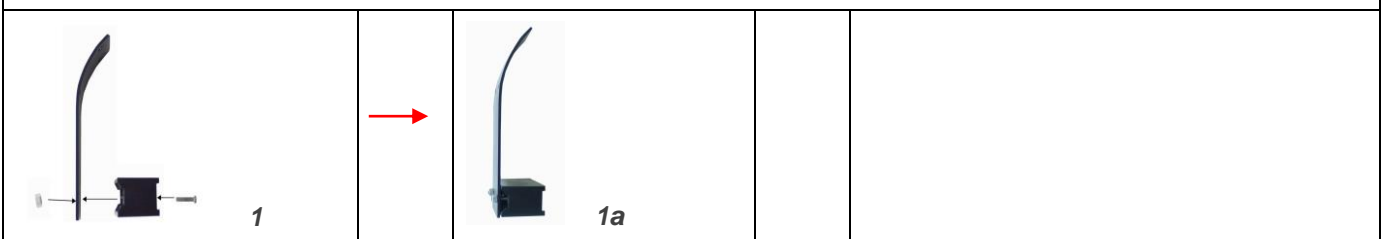

Picture 2-2a: behind the pole (column) assemble the white metal support with screws (B).

Picture 2b: the position is on the right

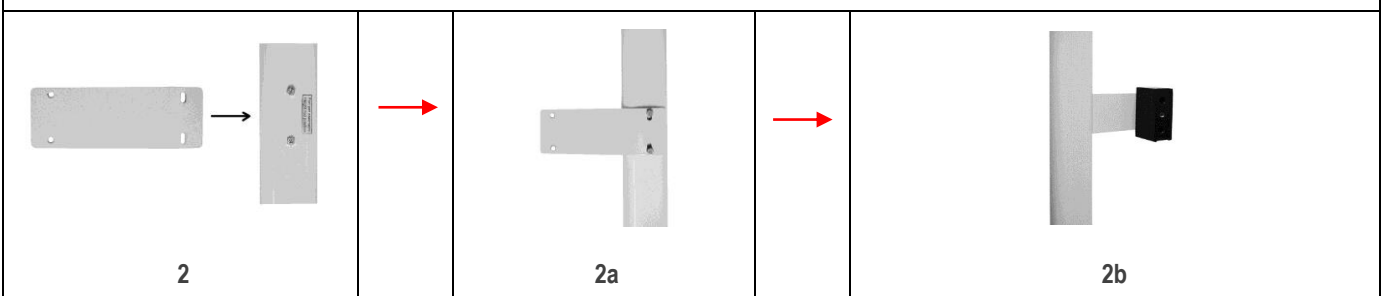

Picture 3-3a: assemble the height rod on black abs support with screws (C) and allen tools kit

Picture 3b: The height rod is ready for use.

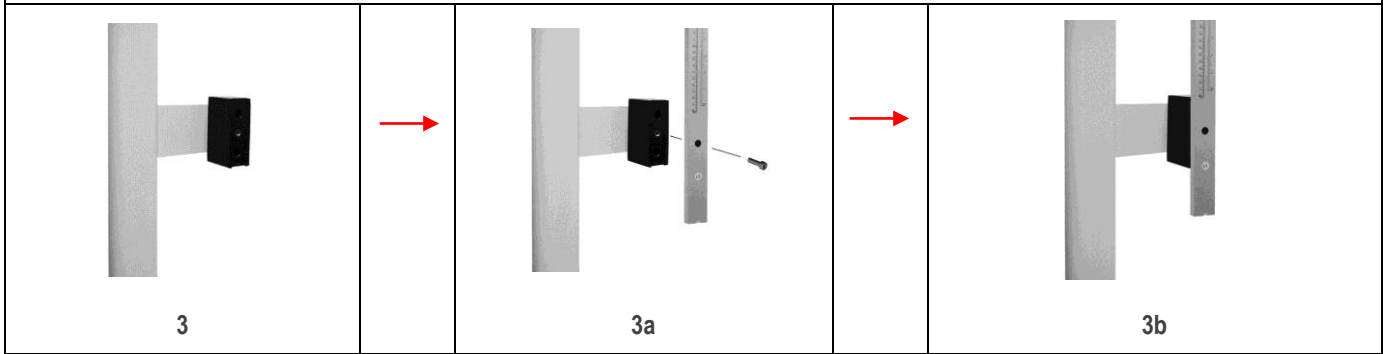

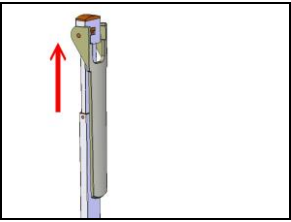
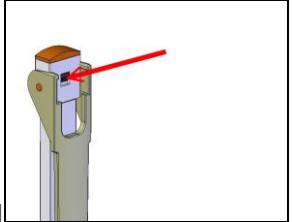
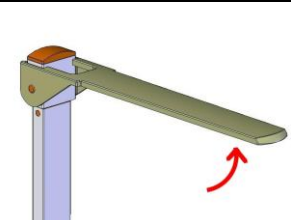
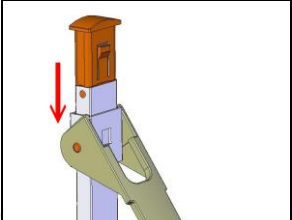
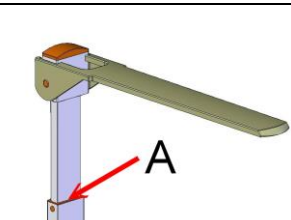
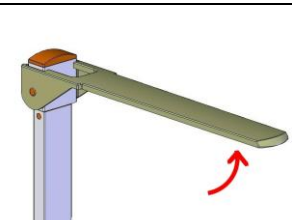
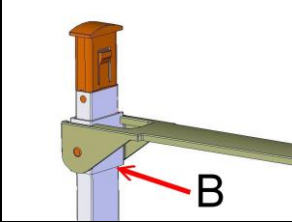
MEASURING OVER 131 cm		MEASURING UNDER 130 cm	
 <p>1</p>	<p>Pull up the height meter rod</p>	 <p>1</p>	<p>Press the black button and measuring height and push down</p>
 <p>2</p>	<p>Position it horizontally</p>	 <p>2</p>	
 <p>3</p>	<p>Lower the rod up to the point where the lever rests head touches the patient's head. The height can be read at the point 'A'</p>	 <p>3</p>	<p>Position it horizontally</p>
		 <p>4</p>	<p>Lower the rod up to the point in which the blade rests head touches the patient's head. The height can be read at point 'B'.</p>

17. THERMAL PRINTER (OPTIONAL)



 Read this manual carefully before using the instrument

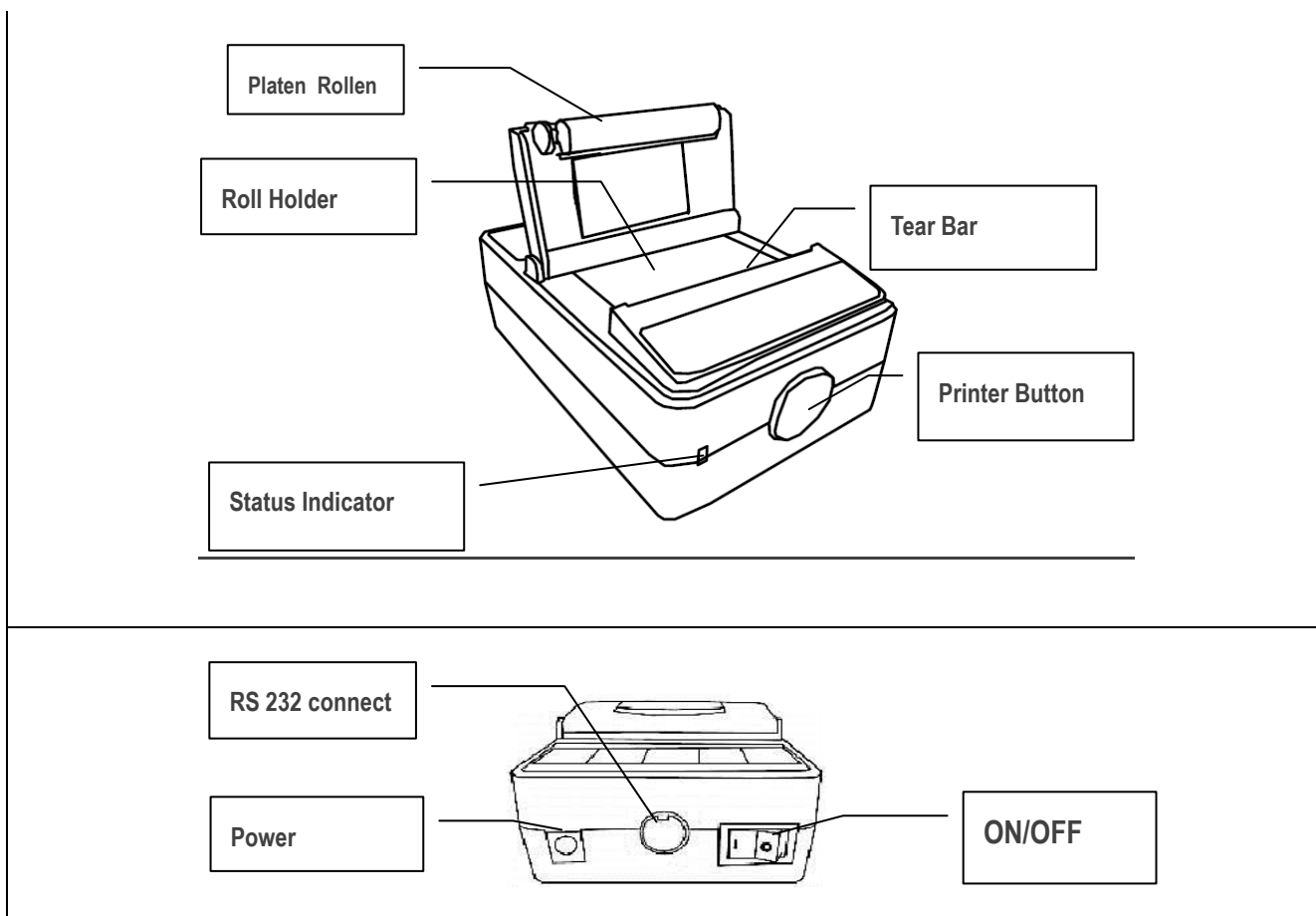

17.1. HOW TO USE YOUR PRINTER

Connect the AC Adaptor and RS232 interface cable. Press the I/O button to power on the printer.

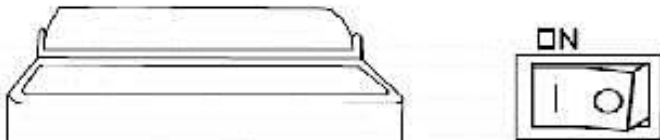

The PRINTER XL printer can be connected via the RS232 port and cable with the RA200 XL.

Press the PRINT key.

Print double language

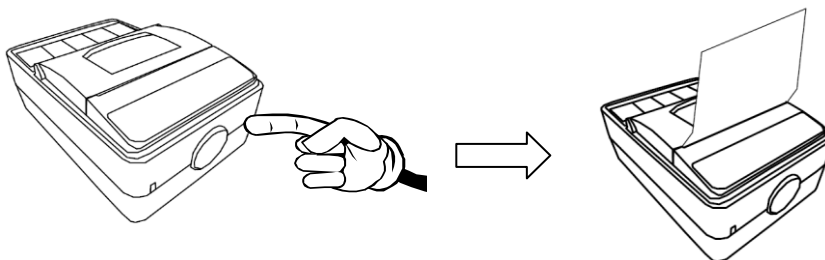

CHANGING THE PAPER ROLL

The paper print roll on a PRINTER XL printer is changed as follows:

1. Open the upper cover and position the paper roll so that it feeds in the right direction.

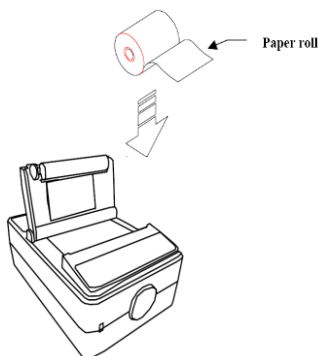

2. Feed the end of the paper roll through the printer cover and close the cover. The printer is ready to print.

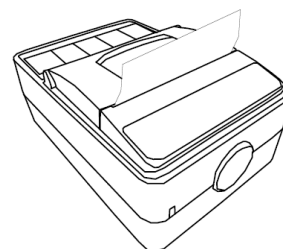

17.2. PRINTER SPECIFICATION

ITEM	SPECIFICATION
Printing method	Thermal dot line printing
Number of dots	384 dot/line
Resolution (dots/mm)	8 dot/mm
Printing width (mm)	48 mm
Max. paper thickness (µm)	80µm
Paper	57.5±0.5 mm (W) x ψ30mm max
Paper loading	Easy loading
Printing speed (mm/s)	75 mm/s
Dimensions (L x W x H)	120 x 80 x 50mm
Operating temperature (°C)	0° to 50°C
Operating humidity (%)	20% to 85% (no condensation)
Interface	Conform to RS232
Voltage range (adaptor only)	12V 2A

SHOCK HAZARD WARNING

The printer and power supply should never be operated in a location where either one can get wet. Personal injury could result.

MEDIA WARNING

Always use high quality approved paper print roll. The approved product can be ordered from your dealer.

RELOADING HINT

If printer runs out of paper roll while printing, switch the power off and reload paper roll. Power on and print again.

17.3. ERROR MESSAGES

Problem	Solution or Reason
Status Indicator does not light when power switch is turned to ON (I) position.	Check the power connections from AC outlet to the printer power supply.
Status indicator illuminated (green light), but the printer will not print.	Check interface cable connections from the scale to printer. Make sure the top cover is closed and locked.
Printer paper jammed.	Reset the paper roll. Please refer to "CHANGING THE PAPER ROLL".
Status Indicator is flashing green.	Paper roll is out. Reload a new source of paper roll so the printer can continue printing. Please refer to "CHANGING THE PAPER ROLL".